

Kostenvoranschlag

Absender / Rechnungsadresse

Bestellung

Versandadresse

Besteller

Datum

Kommission

Max. Belastung 130 kg



Abbildung entspricht nicht der Grundausrüstung

Grundausrüstung

- Grundgestell mit Transportrollen, 100 mm
- Kippsicherung
- Schrägverstellung **via Motor** von 0° bis 85°
- Akku für Notablass
- Durchgehende Fußplatte
- Durchgehende Beinauflage
- Beckenplatte durchgehend mit abschwenkbaren Beckenpelotten
- Rückenauflage
- Leibchen

Gesamtbelastung

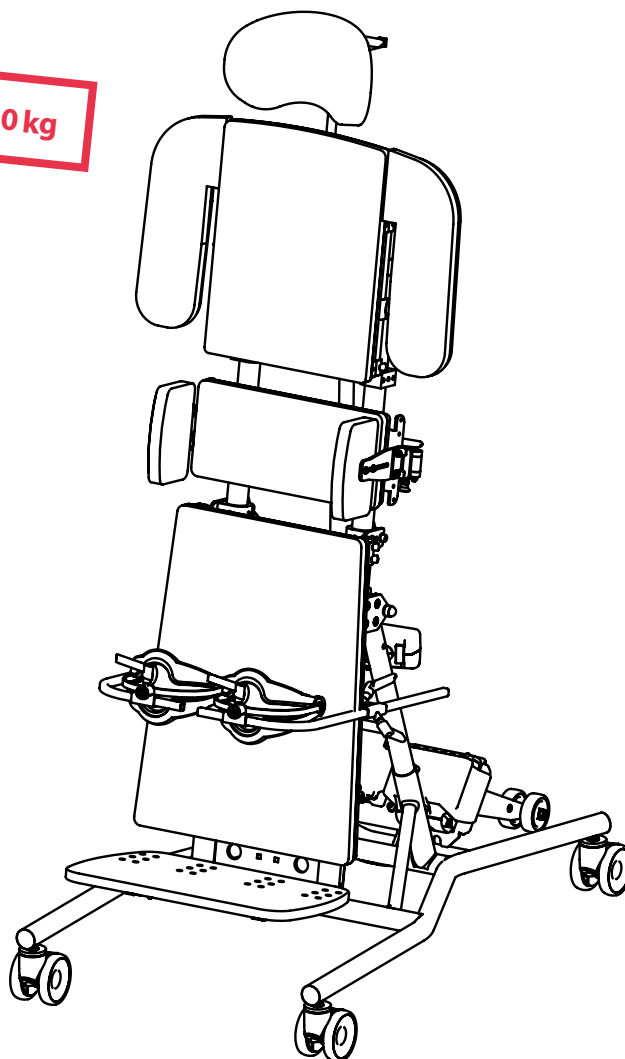
Größe 5 (mit Motor): 130 kg

Trage unten die Maße deines Patienten ein.

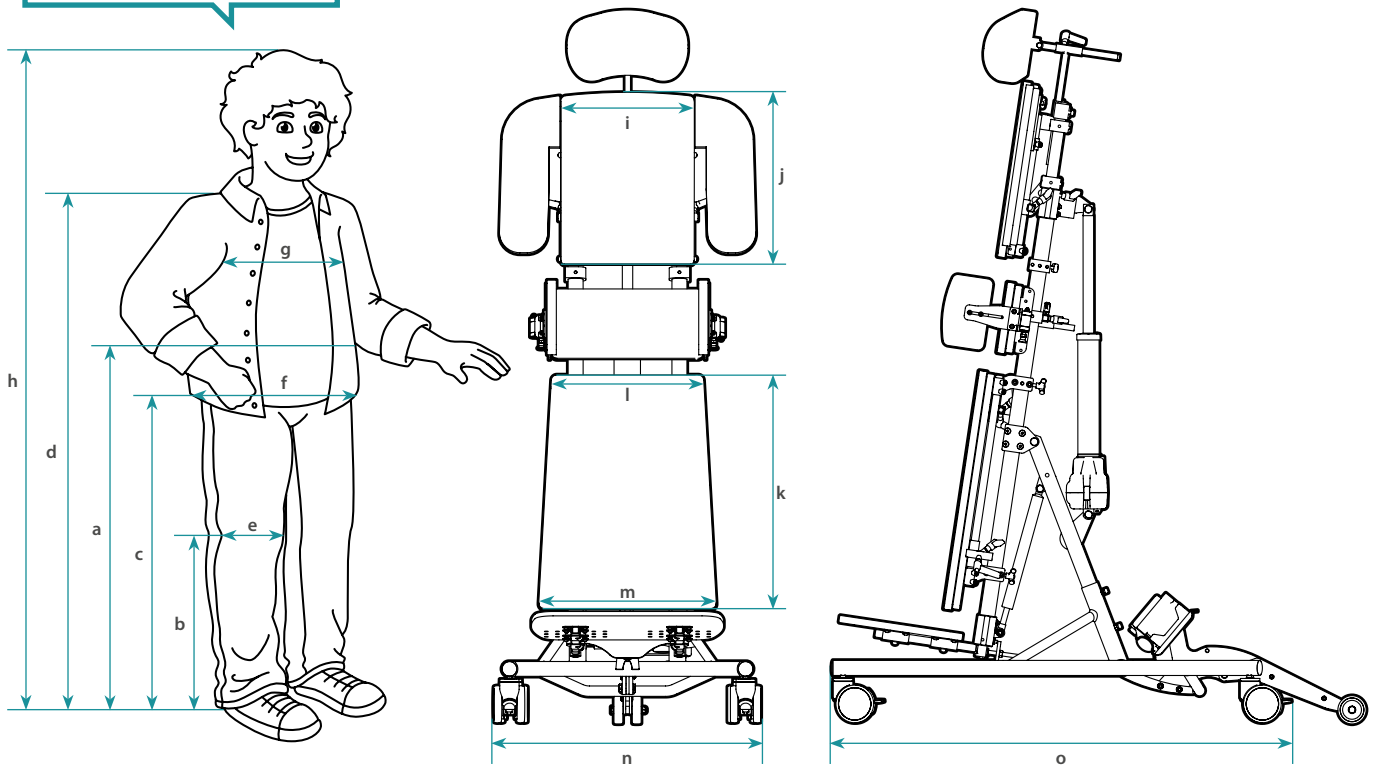

Maßtoleranzen $\pm 3\%$

Patientenmaße

Tischhöhe (a)	Kniehöhe (b)	Höhe Beckenmitte (c)	Schulterhöhe (d)	Kniebreite (e)	Beckenbreite (f)	Brustkorbbreite (g)	Körpergröße (h)
cm	cm	cm	cm	cm	cm	cm	cm

Gerätemaße

Typ	Kantelung	Tischhöhe (a)	Kniehöhe (b)	Höhe Beckenmitte (c)	Schulterhöhe (d)	Kniebreite (e)	Beckenbreite (f)
5	Motor	82 – 115 cm	19 – 100 cm	82 – 105 cm	145 – 175 cm	8 – 14 cm	36 – 51 cm

Typ	Brustkorbbreite (g)	Körpergröße (h)	Rückenplatte (i×j)	Beinauflagen Platten		Gesamtbreite (n)	Gesamtlänge (o)	Transferhöhe ⁽¹⁾
				Höhe (k)	Breite (l/m)			
5	32 – 46 cm	~ 170 – 200 cm	36 × 47 cm	64 cm	40 cm / 47 cm	72 cm	122 cm	93 cm

⁽¹⁾ Mit 100 mm Rollen. Bei 125 mm Rollen + 4,5 cm

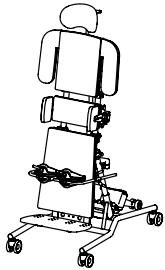
Variante	
<p>Liegebär Lasse Gr. 5, elektrisch verstellbar Code 1018966</p> <p>Für Erwachsene. Schrägverstellung via Motor. Akku für Notablass inklusive.</p> 	<p>Grundpreis 6280.00</p>

Farben	
Gestellfarbe	Bezugskombinationen (Auflagefläche/Rand)
Graphit	Mikrofaser Blau / Grau (N20001 / N20011)
	Mikrofaser Grau / Grau (N20011 / N20011)
	Skai Blau / Blau* (N20052 / N20052)
	*Aufpreis 289,- € netto
	Skai Grau / Grau* (N20051 / N20051)
*Aufpreis 289,- € netto	



Vergiss nicht, die Farben der Bezüge für deinen Lasse auszuwählen. Sie sind für den Bestellvorgang wichtig!

Rollen		Wand- und Möbelschutz									
<p>Transportrollen mit Kick-Feststellbremsen, 100 mm Code 10003-kick100 Unterfahrbare Höhe = 12,5 cm</p> 	<p>Transportrollen mit Feststellbremsen, 125 mm Unterfahrbare Höhe = 17 cm</p> 	<table border="1"> <thead> <tr> <th>Code</th> <th>Rollen</th> </tr> </thead> <tbody> <tr> <td>1018783</td> <td>100 mm</td> </tr> <tr> <td>1018698</td> <td>125 mm</td> </tr> </tbody> </table> 	Code	Rollen	1018783	100 mm	1018698	125 mm	<p>Inklusive</p>	<p>Satz 130.00</p>	<p>Satz 145.00</p>
Code	Rollen										
1018783	100 mm										
1018698	125 mm										

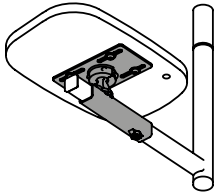
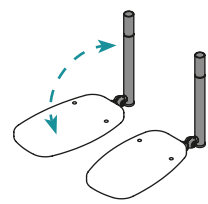
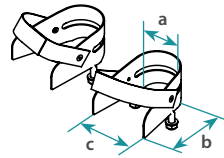
Beinführung		Fußhalterung winkelverstellbar		Fußschalen, inkl. Fußriemen									
<p>Fußbrett geteilt Code 1020345</p> 	<p>Spitzfußkorrektur Code 10051</p>  <p>Nur für Fußbrett geteilt.</p>	<p>Fußhalterung winkelverstellbar Code 1020344 Verstellung durch Zahnsegmente</p> 	<p>Fußschalen, inkl. Fußriemen Code 10069</p>  <table border="1"> <thead> <tr> <th>a</th> <th>b</th> <th>c</th> </tr> </thead> <tbody> <tr> <td>12 cm</td> <td>20 cm</td> <td>14 cm</td> </tr> </tbody> </table>	a	b	c	12 cm	20 cm	14 cm	<p>Optional</p>	<p>Paar 320.00</p>	<p>Paar 350.00</p>	<p>Paar 220.00</p>
a	b	c											
12 cm	20 cm	14 cm											

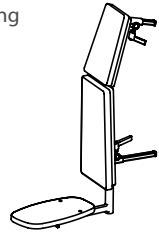
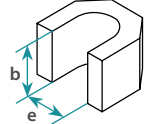
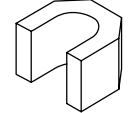
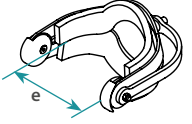
Beinführung, winkelverstellbar		Kniepelotten		Kniepelotten nach Maß		Kniepelotten, anatomisch										
<p>Beinführung, winkelverstellbar Code 1021014 In Entwicklung</p> 	<p>Kniepelotten Code 10045 Farbe: Grau</p>  <table border="1"> <thead> <tr> <th>Maß (e)</th> <th>b</th> </tr> </thead> <tbody> <tr> <td>9 cm</td> <td>12 cm</td> </tr> <tr> <td>11 cm</td> <td>12 cm</td> </tr> </tbody> </table>	Maß (e)	b	9 cm	12 cm	11 cm	12 cm	<p>Kniepelotten nach Maß Code 10045-2 Farbe: Grau</p>  <p>e-Maß = _____ cm</p>	<p>Kniepelotten, anatomisch Code 10074</p>  <table border="1"> <thead> <tr> <th>Maß (e)</th> </tr> </thead> <tbody> <tr> <td>11,5 cm</td> </tr> <tr> <td>13 cm</td> </tr> </tbody> </table>	Maß (e)	11,5 cm	13 cm	<p>Raar 770.00</p>	<p>Paar 665.00</p>	<p>Paar 903.00</p>	<p>Paar 740.00</p>
Maß (e)	b															
9 cm	12 cm															
11 cm	12 cm															
Maß (e)																
11,5 cm																
13 cm																

Beckenführung

Beckenplatte durchgehend, abschwenkbare Beckenpelotten

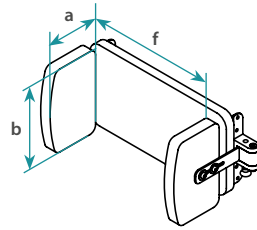

gerade Pelottenhalter

Code	a	b	Maß (f)
1019647	12 cm	19 cm	36-51 cm

Inklusive

Therapietisch

Therapietisch, inkl. Umrandung

Code 1020359

Tiefen- und winkelverstellbar

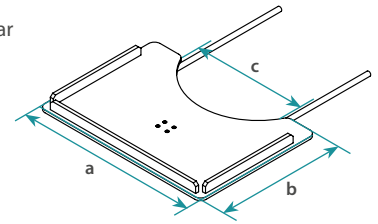

a	b	c
70 cm	50 cm	44 cm

Stück

945.00

Oberkörperführung

Seitenführungspelotten

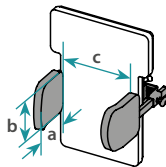

Pelotten	Code	a	b	c
abschwenkbar	10041	14 cm	12 cm	32-46 cm
abnehmbar	10041-1	14 cm	12 cm	32-46 cm

Paar

375.00

Armauflagen, abnehmbar

Code 10042

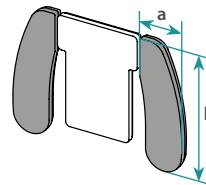

a	b
16 cm	42 cm

Paar

415.00

Schiebebogen

Schiebebogen

Code 10076

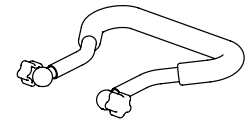

Stück

285.00

Kopfstützen

Kopfstütze, Muschelform

Code 10067

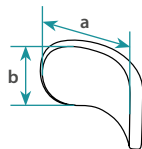

a	b
26 cm	18,5 cm

Stück

285.00

Verstellbare Kopfstütze

Code 10075

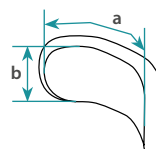

Gr.	a	b	c
1	42 cm	10 cm	10 cm
2	51 cm	14 cm	12 cm

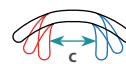

Stück

460.00

Rücksetzadapter

Code 1007669

Inkl. Kopfstützenhalter gerade

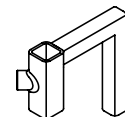

Satz

205.00

Begurtung

Leibchen

Code 10046

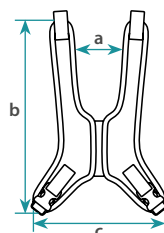

a	b	c
11 cm	36 cm	25 cm

Männlich
Weiblich

Inklusive

Pelvi.Loc Beckengurt

Code 10059

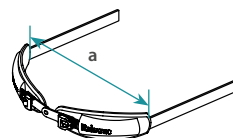

Gr.	Beckenbreite (a)
S	20-32 cm
M	28-38 cm
L	36-46 cm

Stück

220.00

Weitere Sonderbauwünsche
